

INSTALLATION GUIDE



Power Step

Nationally Distributed by Bestop

LIGHT KIT
PART# 10-03303-90

Requires new style control module:

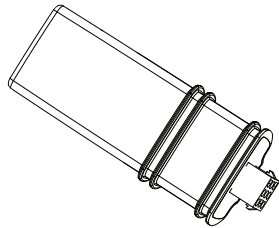

Old style control module will not work:

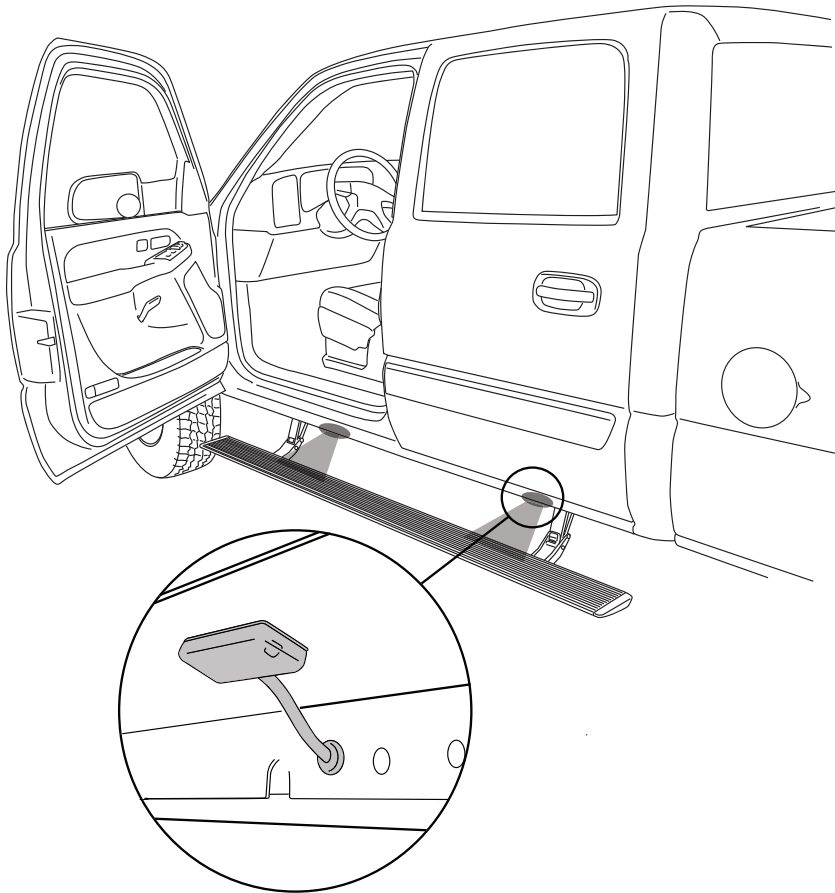
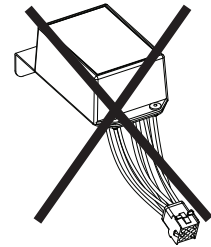

INSTALLATION TIME



1:00 hr

SKILL LEVEL



4= Experienced

TOOLS REQUIRED

- Safety glasses
- Electrical tape
- Tape measure
- Wire cutter
- Wire stripper
- Wire Crimper

TECH SUPPORT **1-888-983-2206** Monday - Friday, 8:00 AM - 5:00 PM PST

Designed and manufactured by AMP Research. Patent 6,830,257 / 6,641,158 / 6,834,875 / 6,938,909 / 6,942,233 / 7,007,961 Other US and worldwide patents pending. Three-year limited warranty. Professional installation is recommended. Nationally Distributed by Bestop.

AMP RESEARCH POWER STEP – LIGHTING KIT

PARTS LIST AND HARDWARE IDENTIFICATION

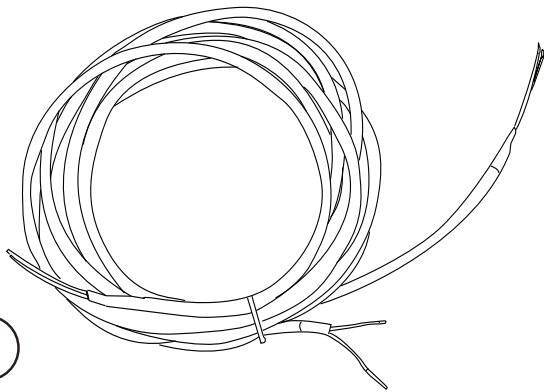

①
80-03303-91
Lighting Kit Harness

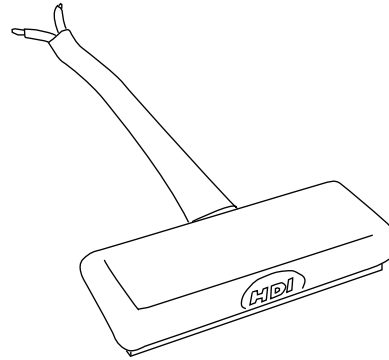

② x4
80-03302-90
LED Lamp

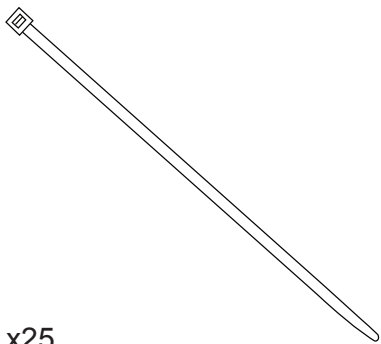

③ x25
19-02805-90
Cable Ties

OPTIONAL : NEEDED IF NOT ALREADY
EQUIPPED WITH POWER STEP.

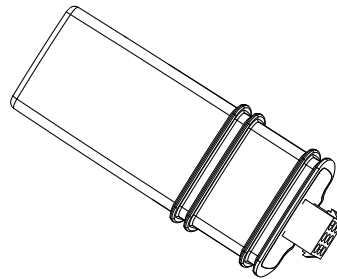

④ (Optional: see note above)
19-03297-93
Controller with Lighting Logic

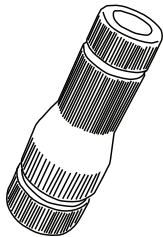

⑤
19-03357-90
Posi-Tap - Black

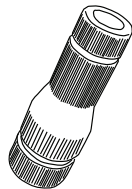

⑥ x4
19-03366-90
Posi-Tap - Blue



⑦ x4
19-02989-90
Butt Connector

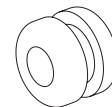

⑧ x4
19-02640-90
Grommet

The lighting kit requires that you have the newer Power Step control module. If you don't have the correct module, the correct part number is listed on the previous page.

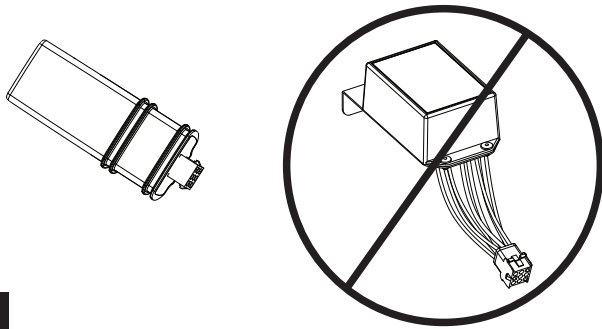

1

Remove Power Step harness from control module, cut cable tie and remove plug of center pin slot. Insert metal terminal of the Lighting Kit harness into center pin slot of connector. Make sure the terminal fully engages.

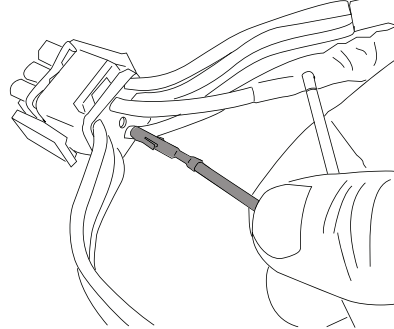

2

Attach supplied black Posi-Tap® to the black wire of Power Step harness. Make sure that the Posi-Tap® threads on straight.

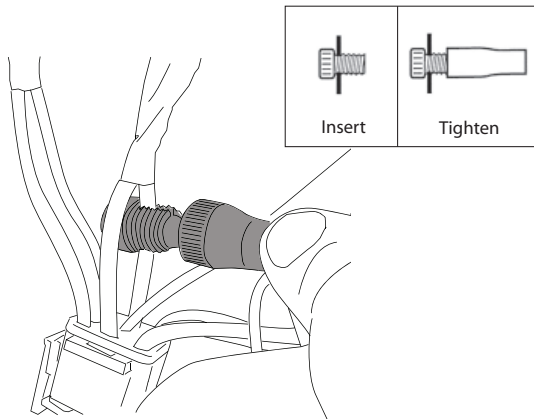

3

Attach black wire of lighting kit harness to Posi-Tap®.

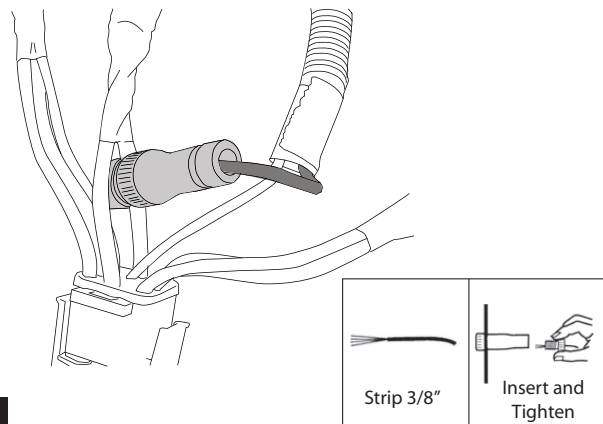

4

Route Lighting kit harness along Power Step harness, securing with cable ties, and back toward rear linkage assembly of each Power Step. Only loosely secure harness along sill.

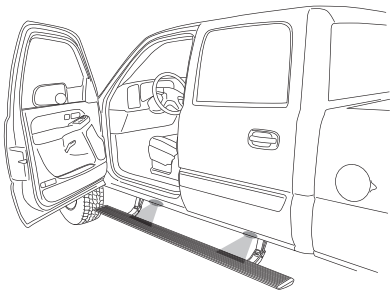

5

Figure out desired lamp locations, two per vehicle side.

For vehicles with vertical pinch weld, drill 1/4" hole through pinch weld at desired lamp locations. Insert grommet and lamp wires through drilled hole.

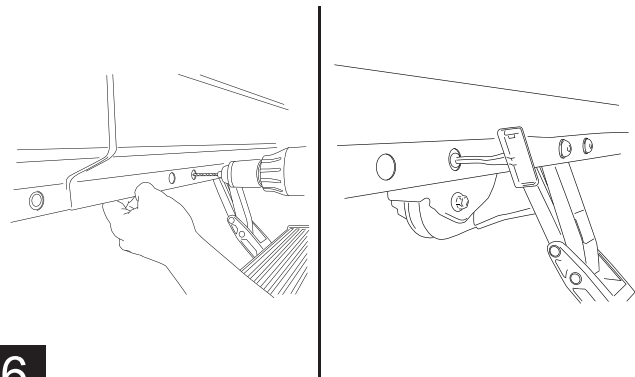

6

AMP RESEARCH POWER STEP – LIGHTING KIT

Affix lamp to rocker panel surface. Make sure the lamp is affixed to a flat, clean surface (ie. GM rocker has a step-down midway across the surface... affix lamp just outside of step-down).

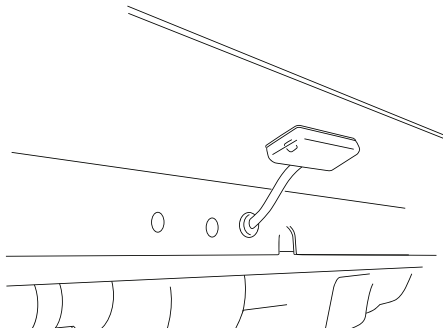

Vehicles with Pinch Weld
(i.e. Ford SD, Dodge Ram, Nissan)

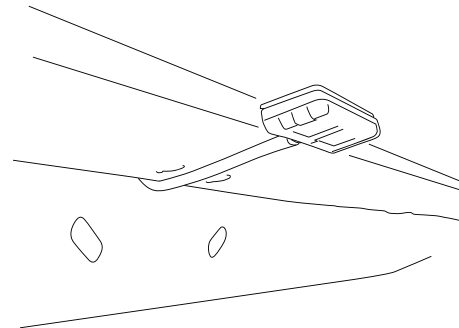

Vehicles without Pinch Weld
(i.e. GM, Ford F150)

7

Trim lighting harness to length so that the wires reach just to the rear mounted lamp. Make sure the conduit is trimmed bit longer so it can cover the connection when complete.

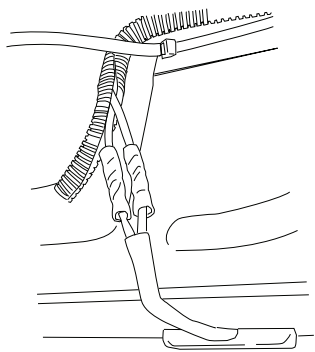

8

Using supplied butt connectors, connect the lamp wires of the rear mounted lamp to the trimmed lighting kit wires, red to red, black to black.

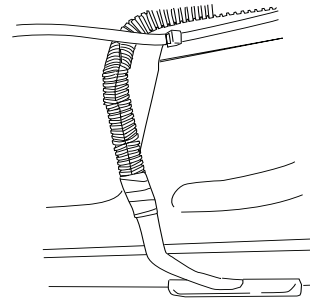

9

Close and wrap with conduit and electrical tape.

Using supplied blue Posi-Tap® connectors, splice forward mounted lamp into lighting kit harness. Tape conduit to keep wires in place. Secure with cable ties.

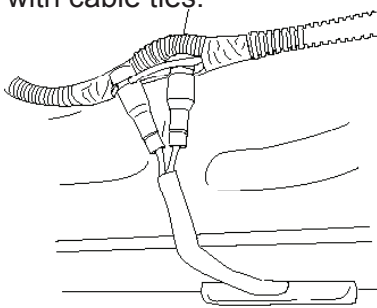

Secure all loose wires with cable ties, with lamp wires pulled upward to avoid any wire snagging. Reconnect Power Step harness to control module.

Correct operation of Lights: All four lamps will illuminate upon opening any door of vehicle. Lamps will stay on until restowing of both Power Steps or until 5 minutes has expired with the doors open. When lights timeout after 5 minutes, they can be reilluminated by closing and/or opening any door of vehicle.

10

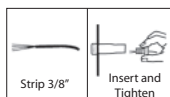
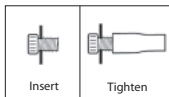

11